



SANITARY PROCESS  
PRODUCTS

**FNW**®

Our origins date back to Familian Northwest, founded in Portland, Oregon, in 1969. In the late 1970s, a group of enterprising sales associates, driven by a commitment to quality and innovation, responded to the pulp and paper industry's needs by developing the first all-cast stainless steel knife gate valve in the United States. Since then, we have continuously expanded our offerings to include high-quality sanitary fittings and valves, all while maintaining our dedication to excellence and serving a diverse range of industries including the food & beverage industry.

## OUR PROMISE



- 1** **QUALITY**  
Our products are held to a high standard of quality and meet or exceed all applicable specifications.
- 2** **DIVERSIFICATION**  
We offer a diversified portfolio, including a variety of specialized and everyday products.
- 3** **CONSISTENCY**  
We're proud to offer products that customers around the world count on each and every day.
- 4** **TRUST**  
Every product we create is done so with the end goal of obtaining and maintaining our customers' trust.

COMMERCIAL



INDUSTRIAL



RESIDENTIAL



FIRE & FABRICATION



HVAC



WATERWORKS



## CLAMP FITTINGS

2CMP - 90° Clamp Short Elbow CC .....	6
2KMP - 45° Clamp Short Elbow CC .....	6
7CMP - Clamp Long Equal Tee .....	7
7RMP - Clamp Long Reducing Tee .....	7
31MP - Clamp Concentric Reducer .....	8
32MP - Clamp Eccentric Reducer .....	9
2WUMP - 180° Clamp U-Bend .....	9
9MP - Clamp Long Equal 4-Way Cross .....	10
2CM - 90° Clamp X Butt weld Long Elbow .....	11
2KM - 45° Clamp X Weld Long Elbow .....	11

## CLAMPS

13MHM - Heavy Duty Single Pin Clamp .....	12
13MHP - High Pressure Clamp .....	12
13MHMD - Double Pin Heavy Duty Clamp .....	13
13MHHS - Three Segment Clamp .....	13

## BUTTWELD FITTINGS

2WK - Butt weld Short Elbow .....	14
2WCL - 90° Butt weld Short Elbow .....	14
2S - 90° Butt weld Long Elbow .....	15
2KS - 45° Butt weld Long Elbow .....	15
7W - Butt weld Long Equal Tee .....	16
7RWW - Butt weld Short Reducing Tee .....	17
7WWW - Butt weld Short Equal Tee .....	18
32W - Butt weld Eccentric Reducer .....	18
31W - Butt weld Concentric Reducer .....	19
16W - Butt weld End Cap .....	20

## ACCESSORIES

21MP - Male NPT X Clamp Adapter .....	21
22MP - Female NPT X Clamp Adapter .....	21
14MPHR - Clamp Rubber Hose Adapter .....	22
14MPHT - Tygon Hose Adapter .....	23
13H - Hexagonal Union Nut .....	23
16AMP - Clamp End Cap .....	24
FNWE24PP - Hex Hanger w/Polypropylene Insert .....	25
FNWE24C - Hex Hanger w/Vinyl Grommet Coupling .....	25
FNWE24 - Hex Hanger w/Vinyl Grommet .....	26

## FERRULES

14RMP - Sanitary Expanding Ferrule .....	26
14AM - Sanitary Long Ferrule .....	27
14WMP - Sanitary Short Ferrule .....	27
14WLMP - Sanitary Long Tank Ferrule .....	28
14MPW - Sanitary Tank Ferrule .....	28

## GASKETS

40MPE - EPDM Gasket .....	29
40MPU - Buna Gasket .....	29
40MPX - Silicone Gasket .....	30
40MPSF - Viton Gasket .....	30
40MP - Teflon Gasket .....	31

## VALVE & ACTUATION

330A - Sanitary Ball Valve .....	32
AC-SERIES - Pneumatic Nickel Infused Rack & Pinion Actuator .....	33

THESE SANITARY FITTINGS ARE WIDELY USED IN SANITARY PROCESSING SYSTEMS WHERE CLEANLINESS, RELIABILITY, AND LONG-TERM DURABILITY ARE CRITICAL.



## FEATURES AND BENEFITS

### Specifications

- FNW Sanitary Process Products comply with 3-A standards

### Materials

- 304 & 316L available

### Clamp Fittings

Clamp style fittings are a popular option due to the ease of assembly and breakdown on process equipment and lines. FNW offers polished ID and OD clamp fittings that comply with the 3-A standard. Clamp fittings require a gasket to provide a good seal and are available in several different materials. FNW offers gaskets in Buna-N, EPDM, Silicone, Teflon and Viton.

### Butt Weld Fittings

Used in industries that require hygienic, smooth, and crevice-free connections to ensure product purity and prevent contamination. These fittings are commonly made of stainless steel and are welded directly to tubing or piping systems to create a seamless, clean-in-place (CIP) process.

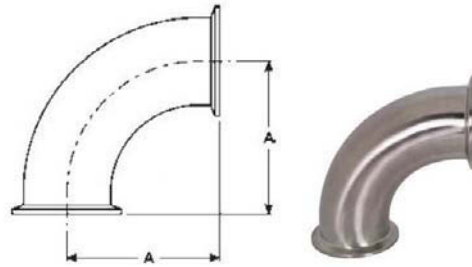

2CMP - 90° CLAMP SHORT ELBOW CC

Part Number		Tube OD (in)	A (in)	Weight (lb)
304	316L			
-	FNW2CMP76D	1/2	1.625	0.132
-	FNW2CMP76F	3/4	1.625	0.286
FNW2CMP74G	FNW2CMP76G	1	2.000	0.352
FNW2CMP74J	FNW2CMP76J	1-1/2	2.750	0.484
FNW2CMP74K	FNW2CMP76K	2	3.500	0.792
FNW2CMP74L	FNW2CMP76L	2-1/2	4.250	1.122
FNW2CMP74M	FNW2CMP76M	3	5.000	1.562
FNW2CMP74P	FNW2CMP76P	4	6.625	3.454
FNW2CMP74U	FNW2CMP76U	6	9.875	9.900
FNW2CMP74X	FNW2CMP76X	8	12.875	16.346

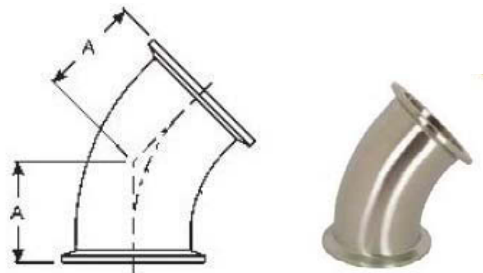

2KMP - 45° CLAMP SHORT ELBOW CC

Part Number		Tube OD (in)	A (in)	Weight (lb)
304	316L			
-	FNW2KMP76D	1/2	0.966	0.088
-	FNW2KMP76F	3/4	0.966	0.176
FNW2KMP74G	FNW2KMP76G	1	1.125	0.286
FNW2KMP74J	FNW2KMP76J	1-1/2	1.437	0.308
FNW2KMP74K	FNW2KMP76K	2	1.750	0.484
FNW2KMP74L	FNW2KMP76L	2-1/2	2.062	0.726
FNW2KMP74M	FNW2KMP76M	3	2.375	1.012
FNW2KMP74P	FNW2KMP76P	4	3.125	2.046
FNW2KMP74U	FNW2KMP76U	6	4.625	5.852
FNW2KMP74X	FNW2KMP76X	8	5.875	9.658

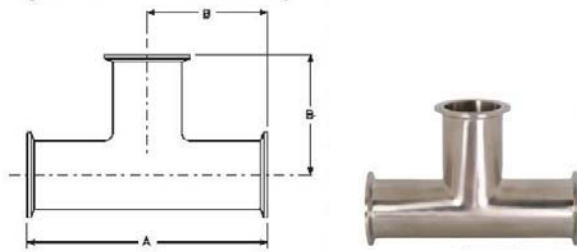

## 7CMP - CLAMP LONG EQUAL TEE

Part Number		Tube OD (in)	A (in)	B (in)	Weight (lb)
304	316L				
-	FNW7MP76D	1/2	4.750	2.375	0.220
-	FNW7MP76F	3/4	5.000	2.500	0.396
FNW7MP74G	FNW7MP76G	1	4.750	2.375	0.616
FNW7MP74J	FNW7MP76J	1-1/2	5.500	2.750	0.704
FNW7MP74K	FNW7MP76K	2	7.000	3.500	1.144
FNW7MP74L	FNW7MP76L	2-1/2	7.000	3.500	1.496
FNW7MP74M	FNW7MP76M	3	7.500	3.750	1.848
FNW7MP74P	FNW7MP76P	4	9.000	4.500	3.652
FNW7MP74U	FNW7MP76U	6	13.000	6.500	7.436
FNW7MP74X	FNW7MP76X	8	15.750	7.875	11.220

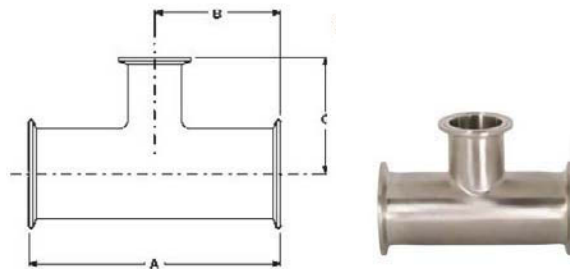

## 7RMP - CLAMP LONG REDUCING TEE

Part Number		Tube OD (in)	A (in)	B (in)	C (in)	Weight (lb)
304	316L					
-	FNW7RMP76JG	1-1/2 X 1	5.500	2.750	2.626	0.704
-	FNW7RMP76KG	2 X 1	7.000	3.500	2.874	1.144
FNW7RMP74KJ	FNW7RMP76KJ	2 X 1-1/2	7.000	3.500	3.000	1.144
FNW7RMP74LK	FNW7RMP76LK	2-1/2 X 2	7.000	3.500	3.752	1.496
FNW7RMP74MJ	FNW7RMP76MJ	3 X 1-1/2	7.500	3.750	3.500	1.848
FNW7RMP74MK	FNW7RMP76MK	3 X 2	7.500	3.750	4.000	1.848
FNW7RMP74PM	FNW7RMP76PM	4 X 3	8.998	4.499	4.122	3.652

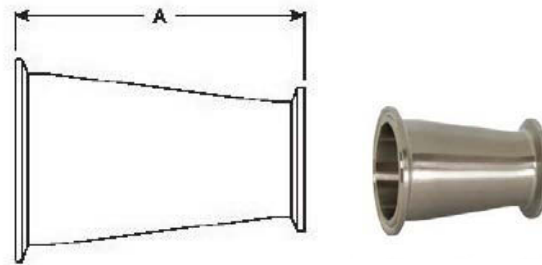

## 31MP - CLAMP CONCENTRIC REDUCER

Part Number		Tube OD (in)	A (in)	Weight (lb)
304	316L			
–	FNW3114MP76FD	3/4 X 1/2	2.000	0.088
–	FNW3114MP76GD	1 X 1/2	2.000	0.264
–	FNW3114MP76GF	1 X 3/4	2.000	0.264
–	FNW3114MP76JD	1-1/2 X 1/2	3.500	0.264
–	FNW3114MP76JF	1-1/2 X 3/4	3.000	0.264
FNW3114MP74JG	FNW3114MP76JG	1-1/2 X 1	3.000	0.352
FNW3114MP74KG	FNW3114MP76KG	2 X 1	5.000	0.616
FNW3114MP74KJ	FNW3114MP76KJ	2 X 1-1/2	3.000	0.616
FNW3114MP74LJ	FNW3114MP76LJ	2-1/2 X 1-1/2	5.000	0.704
FNW3114MP74LK	FNW3114MP76LK	2-1/2 X 2	3.000	0.550
FNW3114MP74MJ	FNW3114MP76MJ	3 X 1-1/2	7.000	1.276
FNW3114MP74MK	FNW3114MP76MK	3 X 2	5.000	1.100
FNW3114MP74ML	FNW3114MP76ML	3 X 2-1/2	3.000	0.726
FNW3114MP74PJ	FNW3114MP76PJ	4 X 1-1/2	11.125	2.310
FNW3114MP74PK	FNW3114MP76PK	4 X 2	9.125	1.980
FNW3114MP74PM	FNW3114MP76PM	4 X 3	5.125	1.584
FNW3114MP74UP	FNW3114MP76UP	6 X 4	7.000	3.388

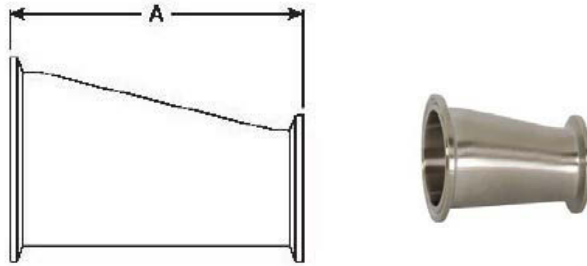

## 32MP - CLAMP ECCENTRIC REDUCER

Part Number		Tube OD (in)	A (in)	Weight (lb)
304	316L			
FNW3214MP74JG	FNW3214MP76JG	1-1/2 X 1	3.000	0.352
FNW3214MP74KG	FNW3214MP76KG	2 X 1	5.000	0.616
FNW3214MP74KJ	FNW3214MP76KJ	2 X 1-1/2	3.000	0.440
FNW3214MP74LJ	FNW3214MP76LJ	2-1/2 X 1-1/2	5.000	0.704
FNW3214MP74LK	FNW3214MP76LK	2-1/2 X 2	3.000	0.550
FNW3214MP74MK	FNW3214MP76MK	3 X 2	5.000	1.100
FNW3214MP74ML	FNW3214MP76ML	3 X 2-1/2	3.000	0.726
FNW3214MP74PK	FNW3214MP76PK	4 X 2	9.125	1.980
FNW3214MP74PL	FNW3214MP76PL	4 X 2-1/2	7.125	1.540
FNW3214MP74PM	FNW3214MP76PM	4 X 3	5.125	1.584
FNW3214MP74UP	FNW3214MP76UP	6 X 4	7.000	3.388

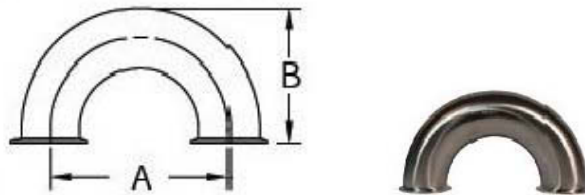

## 2WUMP - 180° CLAMP U-BEND

Part Number		Tube OD (in)	A (in)	B (in)	Weight (lb)
304	316L				
–	FNW2WUMP76D	1/2	–	–	0.200
–	FNW2WUMP76F	3/4	–	–	0.300
FNW2WUMP74G	FNW2WUMP76G	1	3.000	2.500	0.520
FNW2WUMP74J	FNW2WUMP76J	1-1/2	4.500	3.500	0.680
FNW2WUMP74K	FNW2WUMP76K	2	6.000	4.500	1.100
FNW2WUMP74L	FNW2WUMP76L	2-1/2	7.500	5.500	1.760
FNW2WUMP74M	FNW2WUMP76M	3	9.000	6.500	2.580
FNW2WUMP74P	FNW2WUMP76P	4	12.000	8.625	6.120
FNW2WUMP74U	FNW2WUMP76U	6	–	–	12.000

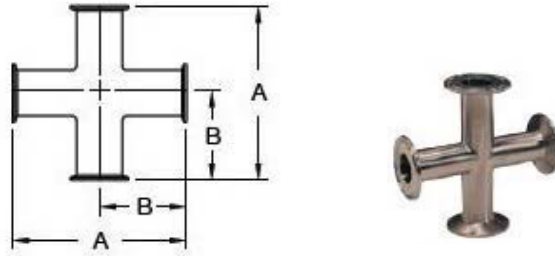

9MP - CLAMP LONG EQUAL 4-WAY CROSS

Part Number		Tube OD (in)	A (in)	B (in)	Weight (lb)
304	316L				
-	FNW9MP76D	1/2	-	-	0.800
-	FNW9MP76F	3/4	-	-	0.850
FNW9MP74G	FNW9MP76G	1	4.750	2.375	0.920
FNW9MP74J	FNW9MP76J	1-1/2	5.500	2.750	1.320
FNW9MP74K	FNW9MP76K	2	7.000	3.500	1.660
FNW9MP74M	FNW9MP76L	2-1/2	7.000	3.500	1.660
FNW9MP74P	FNW9MP76M	3	7.500	3.750	2.200
FNW9MP74L	FNW9MP76P	4	9.000	4.500	3.960
FNW9MP74U	FNW9MP76U	6	-	-	12.000

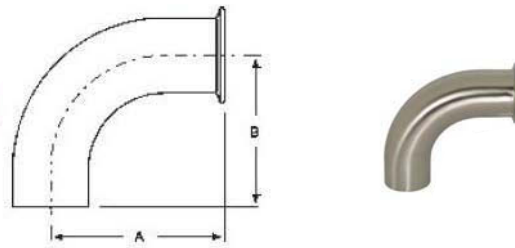

2CM - 90° CLAMP X BUTTWELD LONG ELBOW

Part Number		Tube OD (in)	A (in)	B (in)	Nominal Wall	Weight (lb)
304	316L					
FNW2CM74G	FNW2CM76G	1	2.562	2.062	0.065	0.308
FNW2CM74J	FNW2CM76J	1-1/2	3.438	2.937	0.065	0.528
FNW2CM74K	FNW2CM76K	2	4.562	4.062	0.065	0.836
FNW2CM74L	FNW2CM76L	2-1/2	5.688	5.187	0.065	1.188
FNW2CM74M	FNW2CM76M	3	6.812	6.312	0.065	1.716
FNW2CM74P	FNW2CM76P	4	8.937	8.312	0.083	3.520

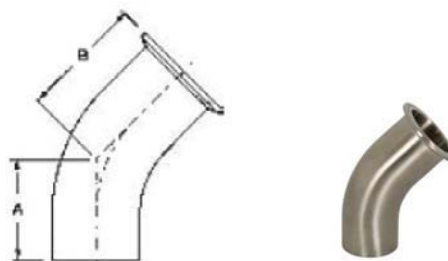

2KM - 45° CLAMP X WELD LONG ELBOW

Part Number	A (in)	B (in)	Nominal Wall	Weight (lb)
304				
FNW2KM74G	1.188	1.688	0.065	0.264
FNW2KM74J	1.625	2.125	0.065	0.352
FNW2KM74K	2.312	2.812	0.065	0.572
FNW2KM74L	3.000	3.500	0.065	0.836
FNW2KM74M	3.688	4.188	0.065	1.100
FNW2KM74P	4.812	5.437	0.083	2.244

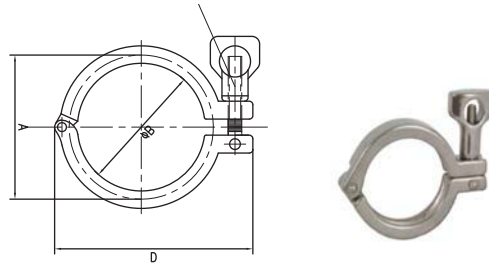

## 13MHHM - HEAVY DUTY SINGLE PIN CLAMP

Part Number	Tube OD (in)	A (in)	B (in)	Weight (lb)
FNW13MHHM4DF	1/2 – 3/4	0.787	1.110	0.374
FNW13MHHM4GJ	1 – 1-1/2	1.748	2.110	0.550
FNW13MHHM4D	1/2	0.787	1.110	0.374
FNW13MHHM4F	3/4	0.787	1.110	0.374
FNW13MHHM4G	1	1.748	2.110	0.440
FNW13MHHM4J	1-1/2	1.748	2.110	0.440
FNW13MHHM4K	2	2.276	2.640	0.616
FNW13MHHM4L	2-1/2	2.811	3.173	0.836
FNW13MHHM4M	3	3.307	3.709	0.880
FNW13MHHM4P	4	4.331	4.811	0.814
FNW13MHHM4U	6	6.118	6.709	1.826
FNW13MHHM4X	8	8.071	8.661	2.266

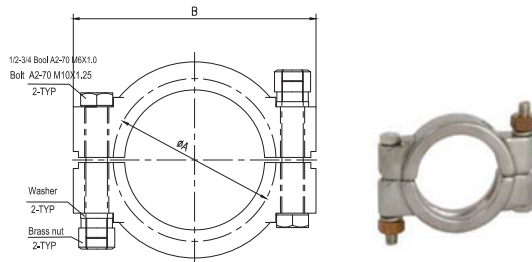

## 13MHP - HIGH PRESSURE CLAMP

Part Number	Nominal Size (in)	A (in)	B (in)	Weight (lb)
FNW13MHP4GJ	1/2 – 3/4	0.787	1.110	0.374
FNW13MHP4F	1 – 1-1/2	1.748	2.110	0.550
FNW13MHP4G	1/2	0.787	1.110	0.374
FNW13MHP4J	3/4	0.787	1.110	0.374
FNW13MHP4K	1	1.748	2.110	0.440
FNW13MHP4L	1-1/2	1.748	2.110	0.440
FNW13MHP4M	2	2.276	2.640	0.616
FNW13MHP4P	2-1/2	2.811	3.173	0.836
FNW13MHP4U	3	3.307	3.709	0.880
FNW13MHP4X	4	4.331	4.811	0.814

All clamps may be utilized for both 304SS and 316SS fittings and are manufactured to industry standards

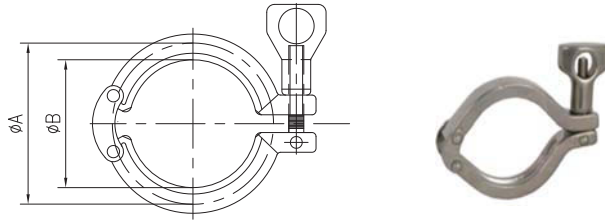

## 13MHHMD - DOUBLE PIN HEAVY DUTY CLAMP

Part Number	Nominal Size (in)	A (in)	B (in)	Weight (lb)
FNW13MHHMDP4D	1/2	0.787	1.102	0.374
FNW13MHHMDP4F	3/4	0.787	1.102	0.374
FNW13MHHMDP4G	1	1.717	2.110	0.440
FNW13MHHMDP4J	1-1/2	1.717	2.110	0.440
FNW13MHHMDP4K	2	2.244	2.638	0.616
FNW13MHHMDP4L	2-1/2	2.780	3.173	0.836
FNW13MHHMDP4M	3	3.307	3.700	0.880
FNW13MHHMDP4P	4	4.409	4.800	0.814
FNW13MHHMDP4U	6	6.102	6.693	0.814
FNW13MHHMDP4X	8	8.071	8.693	2.640



## 13MHHS - THREE SEGMENT CLAMP

Part Number	Nominal Size (in)	A (in)	Weight (lb)
FNW13MHHS4J	1-1/2	2.122	0.506
FNW13MHHS4K	2	2.654	0.924
FNW13MHHS4L	2-1/2	3.185	1.056
FNW13MHHS4M	3	3.717	1.100
FNW13MHHS4P	4	4.820	1.100

All clamps may be utilized for both 304SS and 316SS fittings and are manufactured to industry standards

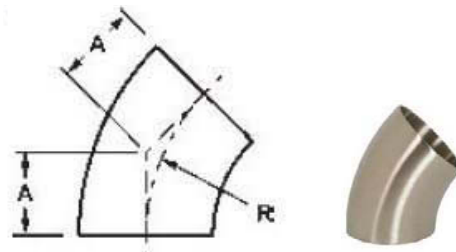

## 2WK - BUTTWELD SHORT ELBOW

Part Number		Tube OD (in)	A (in)	R (in)	Nominal Wall	Weight (lb)
304	316L					
-	FNW2WK76D	1/2	0.466	1.125	0.065	0.044
-	FNW2WK76F	3/4	0.466	1.125	0.065	0.044
FNW2WK74G	FNW2WK76G	1	0.625	1.500	0.065	0.066
FNW2WK74J	FNW2WK76J	1-1/2	0.937	2.250	0.065	0.154
FNW2WK74K	FNW2WK76K	2	1.250	3.000	0.065	0.242
FNW2WK74L	FNW2WK76L	2-1/2	1.562	3.750	0.065	0.418
FNW2WK74M	FNW2WK76M	3	1.875	4.500	0.065	0.594
FNW2WK74P	FNW2WK76P	4	2.500	6.000	0.083	1.408
FNW2WK74U	FNW2WK76U	6	-	-	-	-
FNW2WK74X	FNW2WK76X	8	-	-	-	-

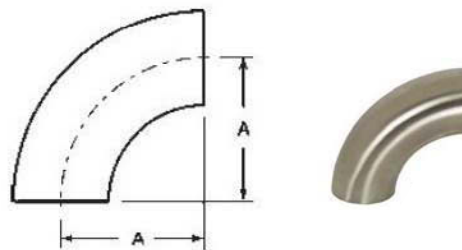

## 2WCL - 90° BUTTWELD SHORT ELBOW

Part Number		Tube OD (in)	A (in)	Nominal Wall	Weight (lb)
304	316L				
-	FNW2WCL76D	1/2	1.125	0.065	0.044
-	FNW2WCL76F	3/4	1.125	0.065	0.088
FNW2WCL74G	FNW2WCL76G	1	1.500	0.065	0.132
FNW2WCL74J	FNW2WCL76J	1-1/2	2.250	0.065	0.308
FNW2WCL74K	FNW2WCL76K	2	3.000	0.065	0.528
FNW2WCL74L	FNW2WCL76L	2-1/2	3.750	0.065	0.836
FNW2WCL74M	FNW2WCL76M	3	4.500	0.065	1.276
FNW2WCL74P	FNW2WCL76P	4	6.000	0.083	2.860
FNW2WCL74U	FNW2WCL76U	6	9.000	0.109	8.184

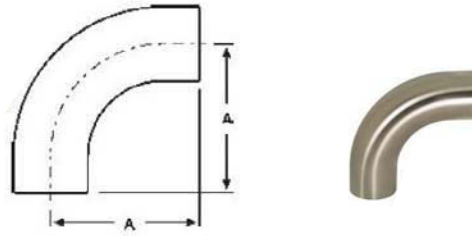

2S - 90° BUTTWELD LONG ELBOW

Part Number		Tube OD (in)	A (in)	Nominal Wall	Weight (lb)
304	316L				
-	FNW2S76D	1/2	3.000	0.065	0.132
-	FNW2S76F	3/4	3.000	0.065	0.220
FNW2S74G	FNW2S76G	1	2.062	0.065	0.220
FNW2S74J	FNW2S76J	1-1/2	2.937	0.065	0.374
FNW2S74K	FNW2S76K	2	4.062	0.065	0.704
FNW2S74L	FNW2S76L	2-1/2	5.187	0.065	1.320
FNW2S74M	FNW2S76M	3	6.312	0.065	1.672
FNW2S74P	FNW2S76P	4	8.312	0.083	3.674

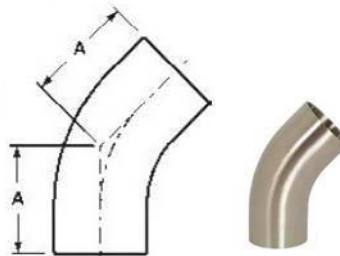

2KS - 45° BUTTWELD LONG ELBOW

Part Number		Tube OD (in)	A (in)	Nominal Wall	Weight (lb)
304	316L				
-	FNW2KS76D	1/2	2.250	0.065	0.088
-	FNW2KS76F	3/4	2.250	0.065	0.176
FNW2KS74G	FNW2KS76G	1	1.188	0.065	0.220
FNW2KS74J	FNW2KS76J	1-1/2	1.625	0.065	0.330
FNW2KS74K	FNW2KS76K	2	2.312	0.065	0.484
FNW2KS74L	FNW2KS76L	2-1/2	3.000	0.065	0.748
FNW2KS74M	FNW2KS76M	3	3.688	0.065	1.166
FNW2KS74P	FNW2KS76P	4	4.812	0.083	2.464
FNW2KS74U	FNW2KS76U	6	6.252	0.109	8.201

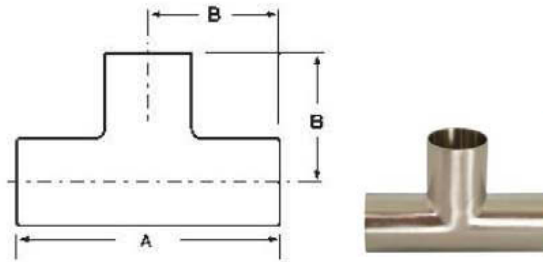

## 7W - BUTTWELD LONG EQUAL TEE

Part Number		Tube OD (in)	A (in)	B (in)	Nominal Wall	Weight (lb)
304	316L					
-	FNW7W76D	1/2	3.750	1.875	0.065	0.132
-	FNW7W76F	3/4	4.000	2.000	0.065	0.264
FNW7W74G	FNW7W76G	1	3.750	1.875	0.065	0.264
FNW7W74J	FNW7W76J	1-1/2	4.500	2.250	0.065	0.528
FNW7W74K	FNW7W76K	2	6.000	3.000	0.065	0.814
FNW7W74L	FNW7W76L	2-1/2	6.000	3.000	0.065	1.034
FNW7W74M	FNW7W76M	3	6.500	3.250	0.065	1.342
FNW7W74P	FNW7W76P	4	7.750	3.875	0.083	2.706
FNW7W74U	FNW7W76U	6	11.250	5.625	0.109	4.070

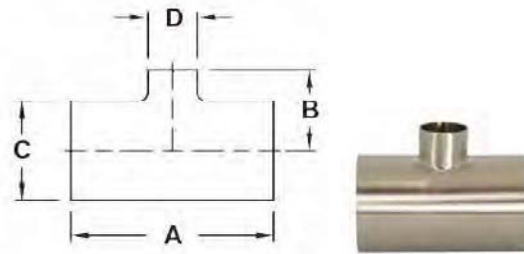

## 7RWWW - BUTTWELD SHORT REDUCING TEE

Part Number		Tube OD (in)	A (in)	B (in)	C (in)	D (in)	Nominal Wall	Weight (lb)
304	316L							
-	FNW7RWWW76GD	1 X 1/2	4.250	2.125	1.000	0.500	0.065	0.308
-	FNW7RWWW76GF	1 X 3/4	4.250	2.125	1.000	0.750	0.065	0.308
-	FNW7RWWW76JD	1-1/2 X 1/2	4.750	2.375	1.500	0.500	0.065	0.484
-	FNW7RWWW76JF	1-1/2 X 3/4	4.750	2.375	1.500	0.750	0.065	0.484
FNW7RWWW74JG	FNW7RWWW76JG	1-1/2 X 1	3.312	1.375	1.500	1.000	0.065	0.484
FNW7RWWW74KD	FNW7RWWW76KD	2 X 1/2	5.750	2.625	2.000	0.500	0.065	0.572
FNW7RWWW74KF	FNW7RWWW76KF	2 X 3/4	5.750	2.625	2.000	0.750	0.065	0.572
FNW7RWWW74KG	FNW7RWWW76KG	2 X 1	4.124	1.625	2.000	1.000	0.065	0.572
FNW7RWWW74KJ	FNW7RWWW76KJ	2 X 1-1/2	4.124	1.906	2.000	1.500	0.065	0.616
FNW7RWWW74LJ	FNW7RWWW76LJ	2-1/2 X 1-1/2	4.688	2.156	2.500	1.500	0.065	0.880
FNW7RWWW74LK	FNW7RWWW76LK	2-1/2 X 2	4.688	2.312	2.500	2.000	0.065	0.792
FNW7RWWW74MJ	FNW7RWWW76MJ	3 X 1-1/2	5.188	2.406	3.000	1.500	0.065	1.012
FNW7RWWW74MK	FNW7RWWW76MK	3 X 2	5.188	2.562	3.000	2.000	0.065	1.012
FNW7RWWW74ML	FNW7RWWW76ML	3 X 2-1/2	5.188	2.594	3.000	2.500	0.083	1.012
FNW7RWWW74PJ	FNW7RWWW76PJ	4 X 1-1/2	6.876	2.906	4.000	1.500	0.083	2.200
FNW7RWWW74PK	FNW7RWWW76PK	4 X 2	6.876	3.062	4.000	2.000	0.083	2.200
FNW7RWWW74PL	FNW7RWWW76PL	4 X 2-1/2	6.876	3.094	4.000	2.500	0.083	2.200

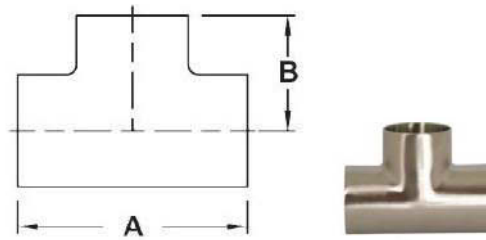

## 7WWW - BUTTWELD SHORT EQUAL TEE

Part Number		Tube OD (in)	A (in)	B (in)	Nominal Wall	Weight (lb)
304	316L					
FNW7WWW74G	FNW7WWW76G	1	2.250	1.125	0.065	0.132
FNW7WWW74J	FNW7WWW76J	1-1/2	3.312	1.656	0.065	0.330
FNW7WWW74K	FNW7WWW76K	2	4.124	2.062	0.065	0.572
FNW7WWW74L	FNW7WWW76L	2-1/2	4.688	2.344	0.065	0.726
FNW7WWW74M	FNW7WWW76M	3	5.188	2.594	0.065	1.078
FNW7WWW74P	FNW7WWW76P	4	6.876	3.438	0.083	2.200
FNW7WWW74U	FNW7WWW76U	6	–	–	–	–

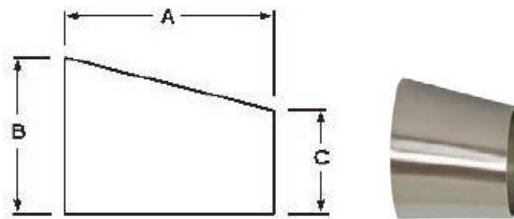

## 32W - BUTTWELD ECCENTRIC REDUCER

Part Number		Tube OD (in)	A (in)	B (in)	C (in)	Nominal Wall	Weight (lb)
304	316L						
–	FNW32W76FD	3/4 X 1/2	1.000	0.750	0.500	0.065	0.066
–	FNW32W76GD	1 X 1/2	1.000	1.000	0.500	0.065	0.088
–	FNW32W76GF	1 X 3/4	1.000	1.000	0.750	0.065	0.088
FNW32W74JG	FNW32W76JG	1-1/2 X 1	2.000	1.500	1.000	0.065	0.132
FNW32W74KG	FNW32W76KG	2 X 1	4.000	2.000	1.000	0.065	0.264
FNW32W74KJ	FNW32W76KJ	2 X 1-1/2	2.000	2.000	1.500	0.065	0.198
FNW32W74LJ	FNW32W76LJ	2-1/2 X 1-1/2	4.000	2.500	1.500	0.065	0.462
FNW32W74LK	FNW32W76LK	2-1/2 X 2	2.000	2.500	2.000	0.065	0.264
FNW32W74MG	FNW32W76MG	3 X 1	8.000	3.000	1.000	0.065	0.770
FNW32W74MJ	FNW32W76MJ	3 X 1-1/2	6.000	3.000	1.500	0.065	0.770
FNW32W74MK	FNW32W76MK	3 X 2	4.000	3.000	2.000	0.065	0.572
FNW32W74ML	FNW32W76ML	3 X 2-1/2	2.000	3.000	2.500	0.065	0.330
FNW32W74PK	FNW32W76PK	4 X 2	8.000	4.000	2.000	0.083	1.474
FNW32W74PL	FNW32W76PL	4 X 2-1/2	6.000	4.000	2.500	0.083	1.210
FNW32W74PM	FNW32W76PM	4 X 3	4.000	4.000	3.000	0.083	0.902
FNW32W74UP	FNW32W76UP	6 X 4	5.500	6.000	4.000	0.109	2.486

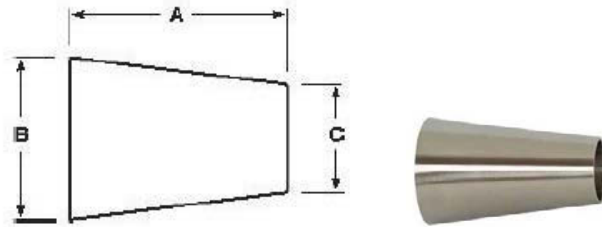

## 31W - BUTTWELD CONCENTRIC REDUCER

Part Number		Tube OD (in)	A (in)	B (in)	C (in)	Nominal Wall	Weight (lb)
304	316L						
–	FNW31W76FD	3/4 X 1/2	1.000	0.750	0.500	0.065	0.066
–	FNW31W76GD	1 X 1/2	1.000	1.000	0.500	0.065	0.088
–	FNW31W76GF	1 X 3/4	1.000	1.000	0.750	0.065	0.088
–	FNW31W76JD	1-1/2 X 1/2	2.500	1.500	0.500	0.065	0.132
–	FNW31W76JF	1-1/2 X 3/4	2.000	1.500	0.750	0.065	0.132
FNW31W74JG	FNW31W76JG	1-1/2 X 1	2.000	1.500	1.000	0.065	0.132
FNW31W74KG	FNW31W76KG	2 X 1	4.000	2.000	1.000	0.065	0.264
FNW31W74KJ	FNW31W76KJ	2 X 1-1/2	2.000	2.000	1.500	0.065	0.198
FNW31W74LJ	FNW31W76LJ	2-1/2 X 1-1/2	4.000	2.500	1.500	0.065	0.462
FNW31W74LK	FNW31W76LK	2-1/2 X 2	2.000	2.500	2.000	0.065	0.264
FNW31W74MG	FNW31W76MG	3 X 1	8.000	3.000	1.000	0.065	0.770
FNW31W74MJ	FNW31W76MJ	3 X 1-1/2	6.000	3.000	1.500	0.065	0.770
FNW31W74MK	FNW31W76MK	3 X 2	4.000	3.000	2.000	0.065	0.572
FNW31W74ML	FNW31W76ML	3 X 2-1/2	2.000	3.000	2.500	0.065	0.330
FNW31W74PK	FNW31W76PK	4 X 2	8.000	4.000	2.000	0.083	1.474
FNW31W74PM	FNW31W76PM	4 X 3	4.000	4.000	3.000	0.083	0.902
FNW31W74UP	FNW31W76UP	6 x 4	5.500	6.000	2.000	0.109	2.486
FNW31W74UK	FNW31W76UK	6 x 2	–	–	–	–	–
FNW31W74UM	FNW31W76UM	6 x 3	–	–	–	–	–
FNW31W74XP	FNW31W76XP	8 x 4	–	–	–	–	–
FNW31W74XU	FNW31W76XU	8 x 6	–	–	–	–	–

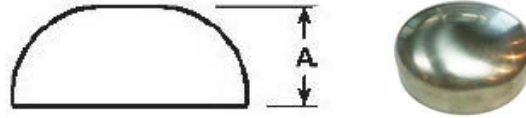

16W - BUTTWELD END CAP

Part Number		Tube OD (in)	A (in)	Weight (lb)
304	316L			
FNW16W74G	FNW16W76G	1	0.375	0.024
FNW16W74J	FNW16W76J	1-1/2	0.562	0.055
FNW16W74K	FNW16W76K	2	0.750	0.330
FNW16W74L	FNW16W76L	2-1/2	1.000	0.220
FNW16W74M	FNW16W76M	3	1.250	0.440
FNW16W74P	FNW16W76P	4	1.500	0.440

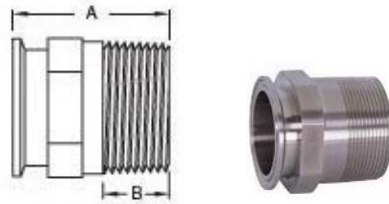

## 21MP - MALE NPT X CLAMP ADAPTER

Part Number		Tube OD (in)	NPT Size (in)	A (in)	B (in)	Weight (lb)
304	316L					
-	FNW21MP76DC	1/2	3/8	2.000	0.600	0.2156
-	FNW21MP76D	1/2	1/2	1.625	0.782	0.2332
-	FNW21MP76FD	3/4	1/2	2.000	0.782	0.2332
-	FNW21MP76F	3/4	3/4	1.787	0.794	0.2332
-	FNW21MP76GD	1	1/2	2.187	0.782	0.704
FNW21MP74GD	FNW21MP76G	1	1	2.250	0.985	0.704
FNW21MP74GJ	FNW21MP76GJ	1	1-1/2	2.438	1.025	0.704
FNW21MP74JF	FNW21MP76JF	1-1/2	3/4	2.187	0.794	0.792
FNW21MP74JG	FNW21MP76JG	1-1/2	1	2.437	0.985	0.792
FNW21MP74J	FNW21MP76J	1-1/2	1-1/2	2.250	1.025	0.792
FNW21MP74KD	FNW21MP76KD	2	1/2	2.188	0.782	1.166
FNW21MP74KG	FNW21MP76KG	2	1	2.469	0.985	1.166
FNW21MP74KJ	FNW21MP76KJ	2	1-1/2	2.625	1.009	1.166
FNW21MP74K	FNW21MP76K	2	2	2.638	1.058	1.166
FNW21MP74L	FNW21MP76L	2-1/2	2-1/2	2.875	1.571	1.5136
FNW21MP74M	FNW21MP76M	3	3	3.070	1.634	2.310
FNW21MP74P	FNW21MP76P	4	4	3.155	1.734	3.432

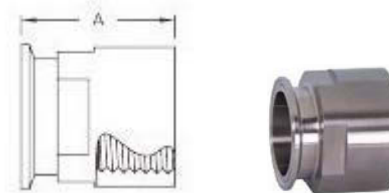

## 22MP - FEMALE NPT X CLAMP ADAPTER

Part Number		Tube OD (in)	A (in)	Weight (lb)
304	316L			
-	FNW22MP76D	1-1/2 X 1	3.000	0.352
-	FNW22MP76F	2 X 1	5.000	0.616
FNW22MP74G	FNW22MP76G	2 X 1-1/2	3.000	0.440
FNW22MP74J	FNW22MP76J	2-1/2 X 1-1/2	5.000	0.704
FNW22MP74K	FNW22MP76K	2-1/2 X 2	3.000	0.550
FNW22MP74L	FNW22MP76L	3 X 2	5.000	1.100
FNW22MP74M	FNW22MP76M	3 X 2-1/2	3.000	0.726
FNW22MP74P	FNW22MP76P	4 X 2	9.125	1.980

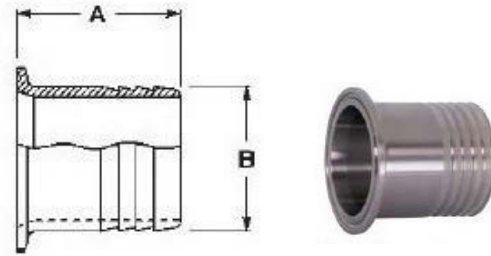

## 14MPHR - CLAMP RUBBER HOSE ADAPTER

Part Number		Tube OD (in)	NPT Size (in)	A (in)	B (in)	Weight (lb)
304	316L					
–	FNW14MPHR76DC	1/2	3/8	1.500	0.400	0.220
–	FNW14MPHR76D	1/2	1/2	1.500	0.500	0.220
–	FNW14MPHR76FB	3/4	1/4	1.500	0.310	0.220
–	FNW14MPHR76FC	3/4	3/8	1.500	0.400	0.220
–	FNW14MPHR76F	3/4	3/4	1.500	0.750	0.220
–	FNW14MPHR76GC	1	3/8	1.500	0.400	0.330
–	FNW14MPHR76GD	1	1/2	1.500	0.500	0.330
FNW14MPHR74GF	FNW14MPHR76GF	1	3/4	1.680	0.750	0.330
FNW14MPHR74G	FNW14MPHR76G	1	1	1.680	1.000	0.330
FNW14MPHR74JF	FNW14MPHR76JF	1-1/2	3/4	1.500	0.750	0.418
FNW14MPHR74JG	FNW14MPHR76JG	1-1/2	1	1.680	1.00	0.418
FNW14MPHR74J	FNW14MPHR76J	1-1/2	1-1/2	1.680	1.500	0.418
FNW14MPHR74K	FNW14MPHR76K	2	2	2.312	1.500	0.594
FNW14MPHR74L	FNW14MPHR76L	2-1/2	2-1/2	2.344	2.500	0.748
FNW14MPHR74M	FNW14MPHR76M	3	3	3.094	3.000	0.946
FNW14MPHR74P	FNW14MPHR76P	4	4	3.406	4.000	1.650

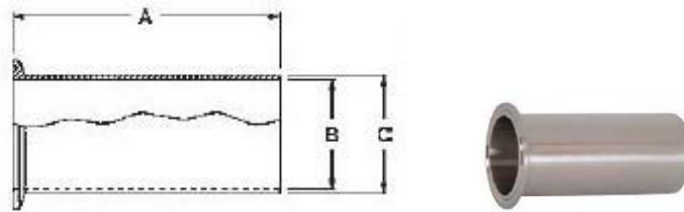

14MPHT - TYGON HOSE ADAPTER

Part Number		Tube OD (in)	A (in)	B (in)	C (in)	Weight (lb)
304	316L					
-	FNW14MPHT76D	1/2	4.000	0.370	0.500	0.250
-	FNW14MPHT76F	3/4	4.000	0.620	0.750	0.300
FNW14MPHT74G	FNW14MPHT76G	1	4.500	0.870	1.000	0.380
FNW14MPHT74J	FNW14MPHT76J	1-1/2	4.500	1.370	1.500	0.420
FNW14MPHT74K	FNW14MPHT76K	2	4.500	1.870	2.000	0.580
FNW14MPHT74L	FNW14MPHT76L	2-1/2	4.500	2.370	2.500	0.740
FNW14MPHT74M	FNW14MPHT76M	3	4.500	2.870	3.000	0.920
FNW14MPHT74P	FNW14MPHT76P	4	4.625	3.834	4.000	1.400
FNW14MPHT74U	FNW14MPHT76U	6	6.000	5.782	6.000	6.100

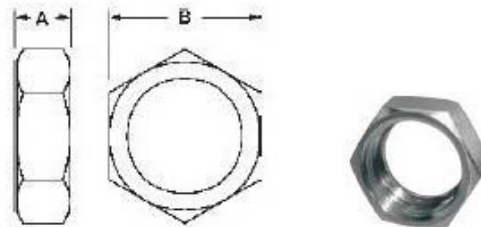

13H - HEXAGONAL UNION NUT

Part Number	Tube OD (in)	A (in)	B (in)	Weight (lb)
304 FNW13H4J	1-1/2	0.968	2.406	0.200
FNW13H4K	2	1.062	3.000	0.814
FNW13H4L	2-1/2	1.187	3.594	1.298
FNW13H4M	3	1.281	4.188	1.826
FNW13H4P	4	1.500	5.438	3.476

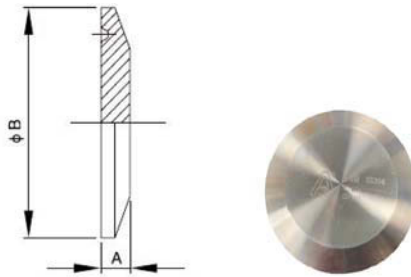

## 16AMP - CLAMP END CAP

Part Number		Size (in)	A (in)	B (in)	Weight (lb)
304	316L				
–	FNW16AMP76D	1/2	5.000	1.000	0.150
–	FNW16AMP76F	3/4	5.000	1.000	0.150
FNW16AMP74DF	FNW16AMP76DF	1/2 – 3/4	–	–	0.150
FNW16AMP74G	FNW16AMP76G	1	6.300	1.984	0.176
FNW16AMP74GJ	FNW16AMP76GJ	1 – 1-1/2	–	–	0.176
FNW16AMP74J	FNW16AMP76J	1-1/2	6.300	1.984	0.176
FNW16AMP74K	FNW16AMP76K	2	6.300	2.519	0.308
FNW16AMP74L	FNW16AMP76L	2-1/2	6.300	3.051	0.462
FNW16AMP74M	FNW16AMP76M	3	6.300	3.582	0.639
FNW16AMP74P	FNW16AMP76P	4	7.900	4.685	1.587
FNW16AMP74U	FNW16AMP76U	6	11.100	6.566	3.811
FNW16AMP74X	FNW16AMP76X	8	11.100	8.571	6.915
FNW16AMP7410	FNW16AMP7610	10	11.100	10.551	10.361
FNW16AMP7412	FNW16AMP7612	12	11.100	12.600	11.023

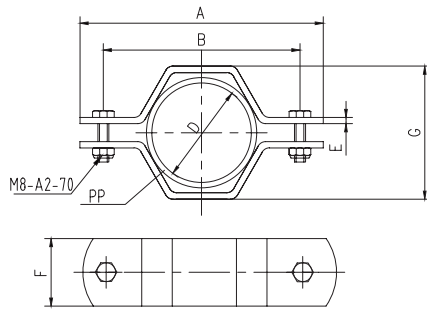

Material: 304 Stainless Steel  
Finish: Stainless

FIGURE FNWE24PP - HEX HANGER W/POLYPROPYLENE INSERT

Part Number	Size	A	B	D ± 0.12	E ± 0.012	F ± 0.03	G ± 0.12
FNWE24PPD	1/2"	2.96 ± 0.12	2.1 ± 0.12	0.50	0.14	1.00	1.00
FNWE24PPF	3/4"	2.93 ± 0.12	2.14 ± 0.12	0.75	0.14	1.00	1.20
FNWE24PPG	1"	3.13 ± 0.12	2.32 ± 0.12	1.00	0.14	0.98	1.48
FNWE24PPJ	1-1/2"	3.68 ± 0.12	2.89 ± 0.12	1.50	0.14	0.98	2.01
FNWE24PPK	2"	4.25 ± 0.12	3.46 ± 0.12	2.00	0.14	0.98	2.50
FNWE24PPL	2-1/2"	4.80 ± 0.197	4.05 ± 0.197	2.50	0.14	0.98	2.95
FNWE24PPM	3"	5.51 ± 0.197	4.70 ± 0.197	3.00	0.14	0.98	3.50
FNWE24PPP	4"	6.75 ± 0.197	5.94 ± 0.197	4.00	0.14	0.98	4.45
FNWE24PPU	6"	9.02 ± 0.197	8.27 ± 0.197	6.00	0.14	0.98	6.34

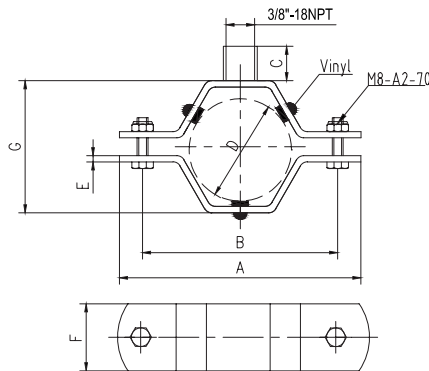

Material: 304 Stainless Steel  
Grommet: Vinyl  
Finish: Stainless

FIGURE FNWE24C - HEX HANGER W/VINYL GROMMET COUPLING

Part Number	Size	A	B	C ± 0.04	D ± 0.12	E ± 0.012	F ± 0.03	G ± 0.12
FNWE24CD	1/2"	2.93 ± 0.12	2.1 ± 0.12	0.81	0.50	0.14	1.00	1.00
FNWE24CF	3/4"	2.93 ± 0.12	2.14 ± 0.12	0.81	0.75	0.14	1.00	1.20
FNWE24CG	1"	3.13 ± 0.12	2.32 ± 0.12	0.81	1.00	0.14	0.98	1.48
FNWE24CJ	1-1/2"	3.68 ± 0.12	2.89 ± 0.12	0.81	1.50	0.14	0.98	2.01
FNWE24CK	2"	4.25 ± 0.12	3.46 ± 0.12	0.81	2.00	0.14	0.98	2.50
FNWE24CL	2-1/2"	4.80 ± 0.197	4.05 ± 0.197	0.81	2.50	0.14	0.98	2.95
FNWE24CM	3"	5.51 ± 0.197	4.70 ± 0.197	0.81	3.00	0.14	0.98	3.50
FNWE24CP	4"	6.75 ± 0.197	5.94 ± 0.197	0.81	4.00	0.14	0.98	4.45
FNWE24CU	6"	9.02 ± 0.197	8.27 ± 0.197	0.81	6.00	0.14	0.98	6.34

Material: 304 Stainless Steel  
 Grommet: Vinyl  
 Finish: Stainless

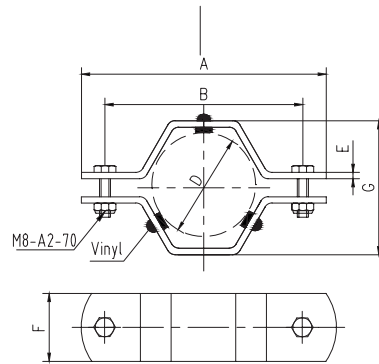
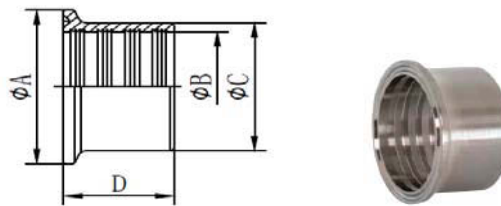

FIGURE FNWE24 - HEX HANGER W/VINYL GROMMET

Part Number	Size	A	B	D ± 0.12	E ± 0.012	F ± 0.03	G ± 0.12
FNWE24D	1/2"	2.93 ± 0.12	2.1 ± 0.12	0.50	0.14	1.00	1.00
FNWE24F	3/4"	2.93 ± 0.12	2.14 ± 0.12	0.75	0.14	1.00	1.20
FNWE24G	1"	3.13 ± 0.12	2.32 ± 0.12	1.00	0.14	0.98	1.48
FNWE24J	1-1/2"	3.68 ± 0.12	2.89 ± 0.12	1.50	0.14	0.98	2.01
FNWE24K	2"	4.25 ± 0.12	3.46 ± 0.12	2.00	0.14	0.98	2.50
FNWE24L	2-1/2"	4.80 ± 0.197	4.05 ± 0.197	2.50	0.14	0.98	2.95
FNWE24M	3"	5.51 ± 0.197	4.70 ± 0.197	3.00	0.14	0.98	3.50
FNWE24P	4"	6.75 ± 0.197	5.94 ± 0.197	4.00	0.14	0.98	4.45
FNWE24U	6"	9.02 ± 0.197	8.27 ± 0.197	6.00	0.14	0.98	6.34

Our Automated Valve Configurator takes care of the sizing for you and generates a CAD file and dimensional data sheet of the complete assembly. Visit [fnw.com](http://fnw.com) to check out this free online tool.



14RMP - SANITARY EXPANDING FERRULE

Part Number		Tube OD (in)	A (in)	B (in)	C (in)	D (in)	Weight (lb)
304	316L						
FNW14RMP74G	FNW14RMP76G	1	1.990	1.000	1.160	.750	0.110
FNW14RMP74J	FNW14RMP76J	1-1/2	1.990	1.500	1.680	1.130	0.150
FNW14RMP74K	FNW14RMP76K	2	2.520	2.000	2.190	1.310	0.240
FNW14RMP74L	FNW14RMP76L	2-1/2	3.050	2.490	2.710	1.370	0.330
FNW14RMP74M	FNW14RMP76M	3	3.580	3.000	3.220	1.440	0.480
FNW14RMP74P	FNW14RMP76P	4	4.690	4.000	4.260	1.500	0.790
FNW14RMP74U	FNW14RMP76U	6	6.570	-	-	1.500	2.200

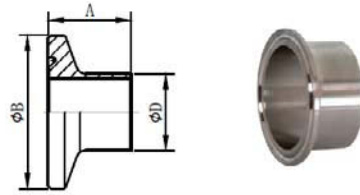

## 14AM - SANITARY LONG FERRULE

Part Number		Size (in)	A(in)	B (in)	D (in)	Weight (lb)
304	316L		L14AM			
FNWL14AM74D	FNWL14AM76D	1/2	1.130	1.000	0.500	0.180
FNWL14AM74F	FNWL14AM76F	3/4	1.130	1.000	0.750	0.200
FNWL14AM74G	FNWL14AM76G	1	1.130	1.990	1.000	0.200
FNWL14AM74J	FNWL14AM76J	1-1/2	1.130	1.990	1.500	0.200
FNWL14AM74K	FNWL14AM76K	2	1.130	2.520	2.000	0.200
FNWL14AM74L	FNWL14AM76L	2-1/2	1.130	3.050	2.500	0.260
FNWL14AM74M	FNWL14AM76M	3	1.130	3.580	3.000	0.330
FNWL14AM74P	FNWL14AM76P	4	1.130	4.690	4.000	0.570
FNWL14AM74S	FNWL14AM76S	5	—	—	—	0.800
FNWL14AM74U	FNWL14AM76U	6	1.500	6.570	6.000	1.100
FNWL14AM74X	FNWL14AM76X	8	1.500	8.570	8.000	1.320
FNWL14AM7410	FNWL14AM7610	10	1.500	10.550	10.000	2.220
FNWL14AM7412	FNWL14AM7612	12	1.500	12.560	12.000	2.850

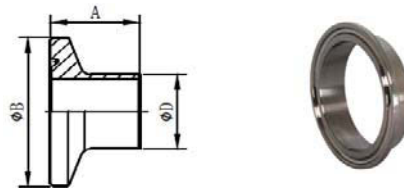

## 14WMP - SANITARY SHORT FERRULE

Part Number		Size (in)	A(in)	B (in)	D (in)	Weight (lb)
304	316L		14WMP			
FNW14WMP74D	FNW14WMP76D	1/2	0.500	1.000	0.500	0.080
FNW14WMP74F	FNW14WMP76F	3/4	0.500	1.000	0.750	0.100
FNW14WMP74G	FNW14WMP76G	1	0.500	1.990	1.000	0.150
FNW14WMP74J	FNW14WMP76J	1-1/2	0.500	1.990	1.500	0.090
FNW14WMP74K	FNW14WMP76K	2	0.500	2.520	2.000	0.130
FNW14WMP74L	FNW14WMP76L	2-1/2	0.500	3.050	2.500	0.170
FNW14WMP74M	FNW14WMP76M	3	0.500	3.580	3.000	0.210
FNW14WMP74P	FNW14WMP76P	4	0.620	4.690	4.000	0.390
FNW14WMP74S	FNW14WMP76S	5	—	—	—	0.770
FNW14WMP74U	FNW14WMP76U	6	0.850	6.570	6.000	0.930
FNW14WMP74X	FNW14WMP76X	8	0.850	8.570	8.000	1.250
FNW14WMP7410	FNW14WMP7610	10	0.850	10.560	10.000	2.000
FNW14WMP7412	FNW14WMP7612	12	0.850	12.560	12.000	2.500

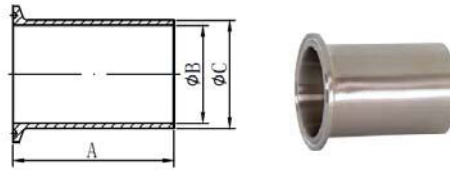

## 14WLMP - SANITARY LONG TANK FERRULE

Part Number		Size (in)	A (in)	B (in)	C (in)	Weight (lb)
304	316L					
FNW14WLMP74G	FNW14WLMP76G	1	3.000	0.870	1.000	0.220
FNW14WLMP74J	FNW14WLMP76J	1-1/2	3.000	1.370	1.500	0.220
FNW14WLMP74K	FNW14WLMP76K	2	3.000	1.870	2.000	0.240
FNW14WLMP74L	FNW14WLMP76L	2-1/2	3.000	2.370	2.500	0.330
FNW14WLMP74M	FNW14WLMP76M	3	4.000	2.870	3.000	0.440
FNW14WLMP74P	FNW14WLMP76P	4	4.000	3.830	4.000	0.770
FNW14WLMP74U	FNW14WLMP76U	6	6.000	5.780	6.000	1.770

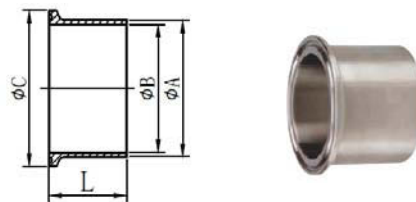

## 14MPW - SANITARY TANK FERRULE

Part Number		Size (in)	A (in)	B (in)	C (in)	L (in)	Weight (lb)
304	316L						
FNW14MPW74D	FNW14MPW76D	1/2	-	-	-	-	0.150
FNW14MPW74F	FNW14MPW76F	3/4	-	-	-	-	0.160
FNW14MPW74G	FNW14MPW76G	1	1.160	0.870	1.990	1.630	0.170
FNW14MPW74J	FNW14MPW76J	1-1/2	1.680	1.370	1.990	1.630	0.190
FNW14MPW74K	FNW14MPW76K	2	2.190	1.870	2.520	1.750	0.220
FNW14MPW74L	FNW14MPW76L	2-1/2	2.710	2.370	3.050	1.750	0.330
FNW14MPW74M	FNW14MPW76M	3	3.220	2.870	3.580	1.810	0.400
FNW14MPW74P	FNW14MPW76P	4	4.260	3.830	4.690	2.130	0.660
FNW14MPW74U	FNW14MPW76U	6	-	-	-	-	0.800
FNW14MPW74X	FNW14MPW76X	8	-	-	-	-	1.500

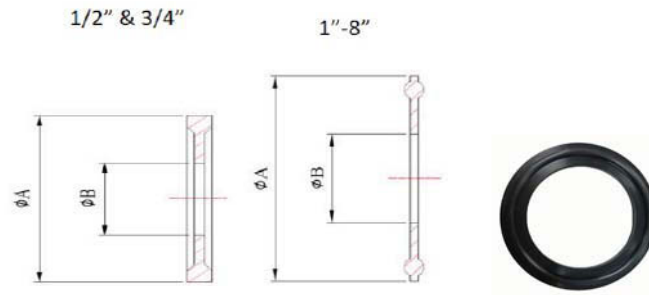

## 40MPE - EPDM GASKET

Part Number Black	Size (in)	A (in)	B (in)	Weight (lb)
FNW40MPED	1/2	0.860	0.390	0.002
FNW40MPEF	3/4	0.860	0.640	0.002
FNW40MPEG	1	1.970	0.890	0.010
FNW40MPEJ	1-1/2	1.970	1.410	0.006
FNW40MPEK	2	2.500	1.910	0.009
FNW40MPEL	2-1/2	3.000	2.410	0.011
FNW40MPER	3	3.500	2.910	0.014
FNW40MPEP	4	4.650	3.880	0.021
FNW40MPEU	6	6.500	5.820	0.030

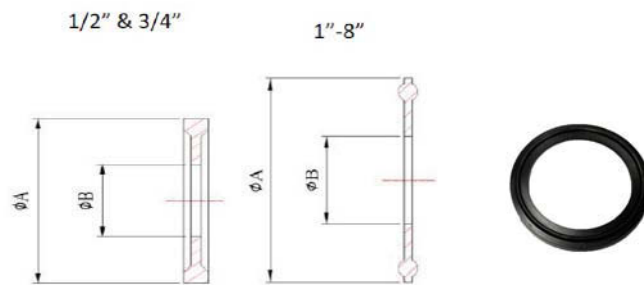

## 40MPU - BUNA GASKET

Part Number Black	Part Number White	Size (in)	A (in)	B (in)	Weight (lb)
FNW40MPUD	FNW40MPUWD	1/2	0.860	0.390	0.002
FNW40MPUF	FNW40MPUWF	3/4	0.860	0.640	0.002
FNW40MPUG	FNW40MPUWG	1	1.970	0.890	0.010
FNW40MPUJ	FNW40MPUWJ	1-1/2	1.970	1.410	0.006
FNW40MPUK	FNW40MPUWK	2	2.500	1.910	0.009
FNW40MPUL	FNW40MPUWL	2-1/2	3.000	2.410	0.011
FNW40MPUM	FNW40MPUWM	3	3.500	2.910	0.014
FNW40MPUP	FNW40MPUWP	4	4.650	3.880	0.021
FNW40MPUU	FNW40MPUWU	6	6.500	5.820	0.030
FNW40MPUX	-	8	8.500	7.820	0.040

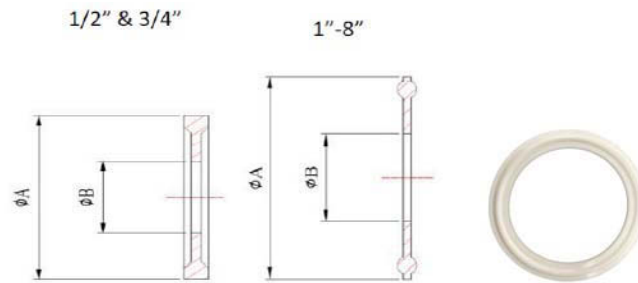

## 40MPX - SILICONE GASKET

Part Number		Size (in)	A (in)	B (in)	Weight (lb)
White	Clear				
FNW40MPXWG	–	1	1.970	0.890	0.010
FNW40MPXWJ	FNW40MPXCJ	1-1/2	1.970	1.410	0.006
FNW40MPXWK	FNW40MPXCK	2	2.500	1.910	0.009
FNW40MPXWL	FNW40MPXCL	2-1/2	3.000	2.410	0.011
FNW40MPXWM	FNW40MPXCM	3	3.500	2.910	0.014
FNW40MPXWP	FNW40MPXCP	4	4.650	3.880	0.021

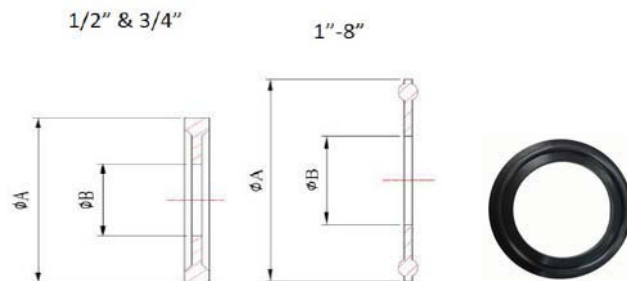

## 40MPSF - VITON GASKET

Part Number	Size (in)	A (in)	B (in)	Weight (lb)
Black				
FNW40MPSFYD	1/2	0.860	0.390	0.004
FNW40MPSFYF	3/4	0.860	0.640	0.003
FNW40MPSFYG	1	1.970	0.890	0.0160
FNW40MPSFYJ	1-1/2	1.970	1.410	0.011
FNW40MPSFYK	2	2.500	1.910	0.014
FNW40MPSFYL	2-1/2	3.000	2.410	0.019
FNW40MPSFYM	3	3.500	2.910	0.024
FNW40MPSFY P	4	4.650	3.880	0.037
FNW40MPSFYU	6	6.500	5.820	0.050

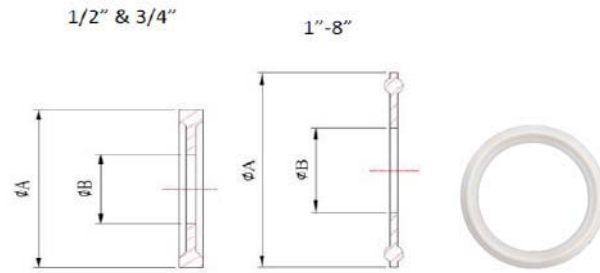

## 40MP - TEFLON GASKET

Part Number White	Size (in)	A (in)	B (in)	Weight (lb)
FNW40MPGD	1/2	0.860	0.390	0.004
FNW40MPGF	3/4	0.860	0.640	0.007
FNW40MPGG	1	1.970	0.890	0.020
FNW40MPGJ	1-1/2	1.970	1.410	0.015
FNW40MPGK	2	2.500	1.910	0.019
FNW40MPGL	2-1/2	3.000	2.410	0.024
FNW40MPGM	3	3.500	2.910	0.028
FNW40MPGP	4	4.650	3.880	0.046
FNW40MPGU	6	6.500	5.820	0.065
FNW40MPGX	8	8.500	7.820	0.070

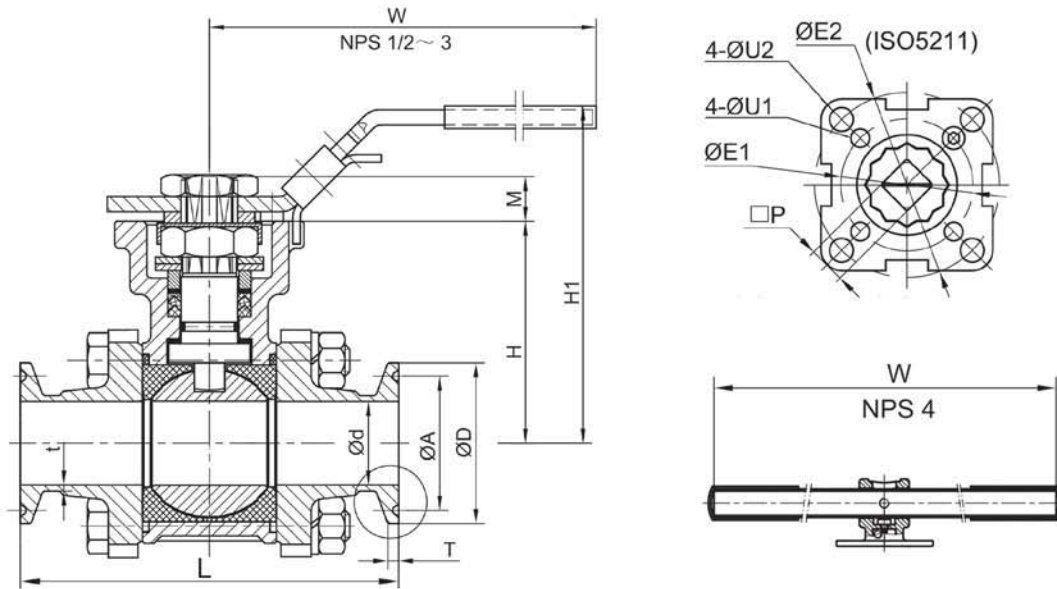

## 330A - SANITARY BALL VALVE

Part Number	Size	Ød	L	H1	H	W	ØA	ØB	T	M	ØE1	ØE2	P	U1	U2	K (UNF)
FNW330AD	1/2"	0.37	3.54	1.66	2.83	5.79	0.80	0.98	0.14	0.35	F03	F04	0.35	0.24	0.24	7/16-20
FNW330AF	3/4"	0.62	3.54	1.91	3.11	5.79	0.80	0.98	0.14	0.35	F03	F05	0.35	0.24	0.28	7/16-20
FNW330AG	1"	0.87	3.94	2.32	3.58	6.97	1.71	1.99	0.11	0.43	F04	F05	0.43	0.24	0.28	9/16-18
FNW330AJ	1-1/2"	1.37	4.92	2.81	4.06	7.76	1.71	1.99	0.11	0.55	F05	F07	0.55	0.28	0.35	3/4-16
FNW330AK	2"	1.87	5.91	3.08	4.33	7.76	2.22	2.52	0.11	0.55	F05	F07	0.55	0.28	0.35	3/4-16
FNW330AL	2-1/2"	2.37	7.48	3.94	5.91	10.51	2.28	3.05	0.11	0.67	F07	F10	0.67	0.35	0.43	7/8-14
FNW330AM	3"	2.87	8.66	4.27	6.26	10.51	3.29	3.58	0.11	0.67	F07	F10	0.67	0.35	0.43	7/8-14
FNW330AP	4"	3.83	10.63	5.51	8.35	15.75	4.33	4.69	0.11	0.87	-	F10	0.87	-	0.43	1-1/8-12

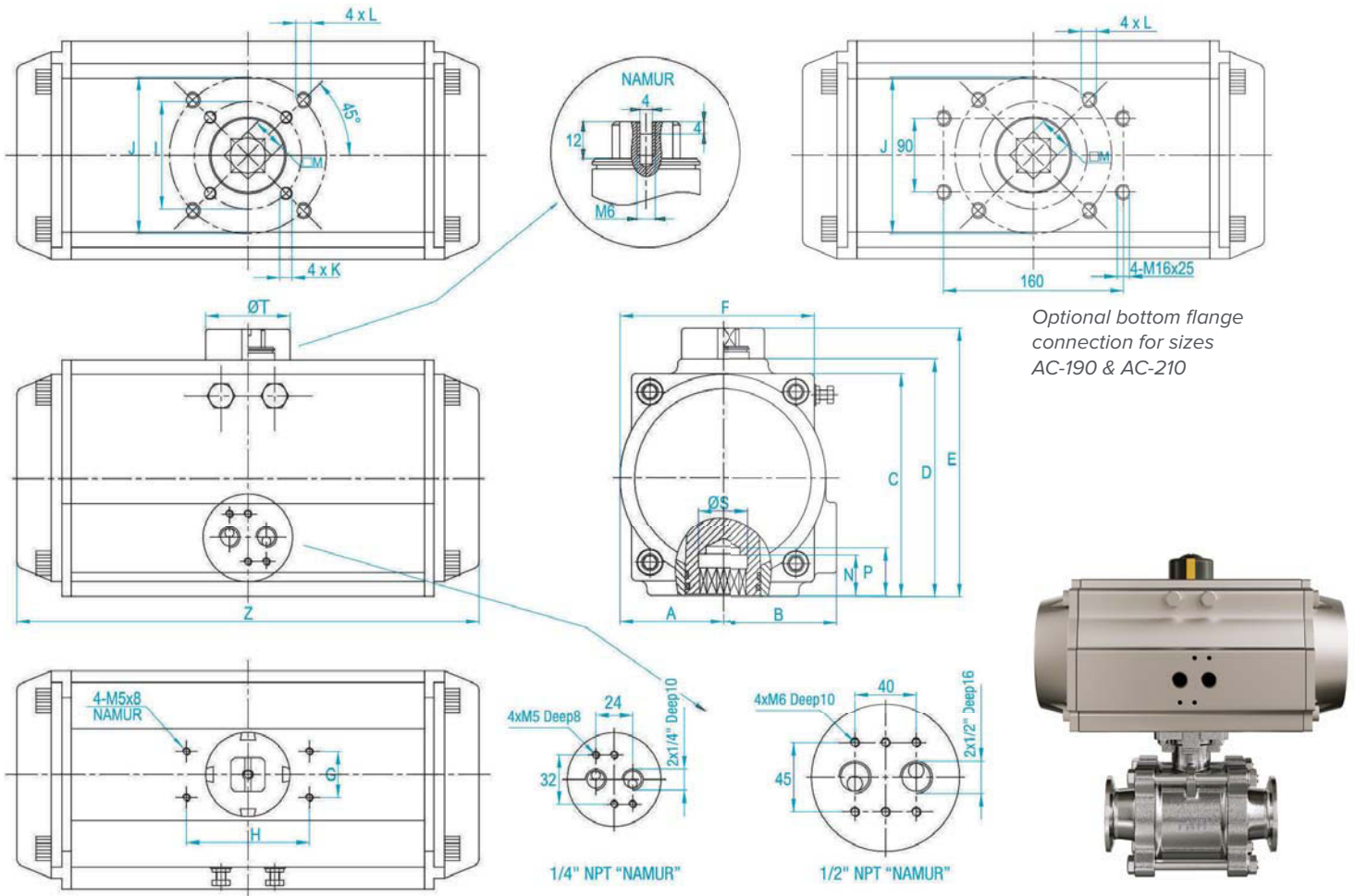

## AC-SERIES - PNEUMATIC NICKEL INFUSED RACK & PINION ACTUATOR

Part Number	A	B	C	D	E	F	G	H	I	J	K	L	M	N	P	$\emptyset S$	Z	$\emptyset T$	Air Connection
FNWAC52SR11VN	30	42	66	72	92	65	30	80	F03	F05	M5X8	M6X10	11	14	15	10	146	40	1/4" NPT
FNWAC63SR11VN	36	47	81	88	108	72	30	80	F05	F07	M6X10	M8X13	14	18	19	13	167	40	1/4" NPT
FNWAC75SR11VN	42	53	94	100	120	81	30	80	F05	F07	M6X10	M8X13	17	19	32	16	180	40	1/4" NPT
FNWAC83SR11VN	46	57	99	109	129	92	30	80	F05	F07	M6X10	M8X13	17	21	32	20	204	40	1/4" NPT
FNWAC92SR11VN	50	59	111	117	137	98	30	80	F05	F07	M6X10	M8X13	17	21	22	16	258	40	1/4" NPT
FNWAC105SR11VN	58	64	123	133	153	110	30	80	F07	F10	M8X13	M10X16	22	26	33	27	370	40	1/4" NPT
FNWAC125SR11VN	68	75	146	155	175	128	30	80	F07	F10	M8X13	M10X16	22	26	33	27	302	55	1/4" NPT
FNWAC140SR12VN	75	77	161	172	192	138	30	80	F10	F12	M10X16	M12X20	36	38	51	38.5	394	55	1/4" NPT

Our Automated Valve Configurator takes care of the sizing for you and generates a CAD file and dimensional data sheet of the complete assembly. Visit [FNW.com](http://FNW.com) to check out this free online tool.





# **FNW.COM**

The contents of this publication are presented for information purposes only, and while every effort has been made to ensure their accuracy, they are not to be construed as warranties or guarantees, expressed or implied, regarding the products or services described herein or their use or applicability. All sales are governed by our terms and conditions, which are available on request. We reserve the right to modify or improve the designs or specifications of our products at any time without notice. Always verify that you have the most recent product specifications or other documentation prior to the installation of these products.